



中山市晶博光电科技有限公司

ZHONGSHAN KINGHOOD OPTOELECTRONICS CO.,LTD.

Device Number: JBDL-4E2-013

REV: 1.0

3.2*3.9mm Elliptical Wide Angle LED Lamps

Model No.: **346A25BXXD1**

ECN: _____ Page: 1/4

■ Features :

- High radiant intensity
- Choice of various viewing angles
- Reliable and robust

■ Descriptions :

- The series is specially designed for applications requiring higher brightness.
- The led lamps are available with different colors, intensities, epoxy colors, etc.

■ Applications :

- TV set
- Monitor
- Telephone
- Computer

■ Package Dimensions:

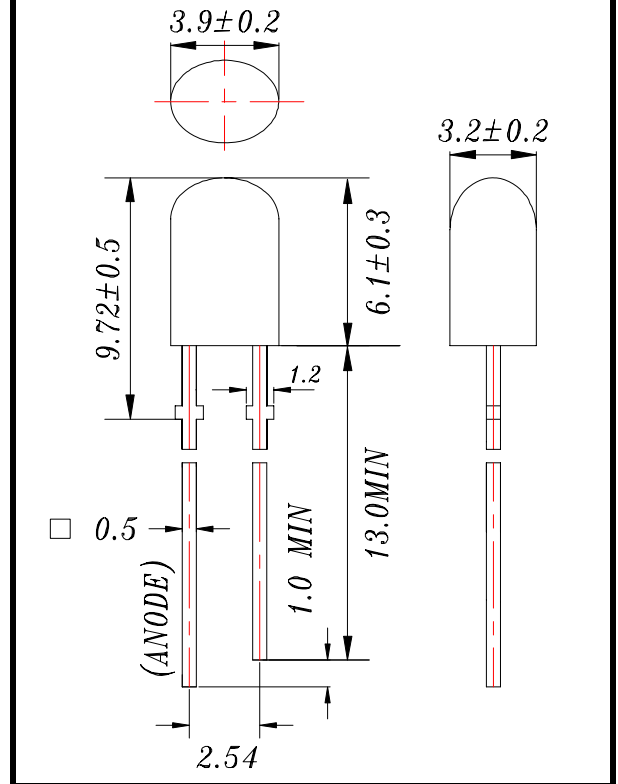

- Notes:**
1. All dimensions are in millimetres
 2. An epoxy meniscus may extend about 1.5mm(0.059") down to the lead.
 3. Tolerances unless Dimension ± 0.25 mm.

PART NO.	Chip		Lens Color
	Material	Emitted Color	
346A25BXXD1	InGaN/SiC	Blue	Tinted Diffused

Address: Bld.8,Fuwan Industrial Zone,Eastern,Zhongshan,Guangdong,China

TEL : (+86 760) 86185231 86185232 86185233 86185201

FAX : (+86 760) 86185230

E-mail: Sales@kinghood.cc

Http://www.kinghood.cc

Prepared by: George

Prepared date: 09-6-14

906028



中山市晶博光电科技有限公司

ZHONGSHAN KINGHOOD OPTOELECTRONICS CO.,LTD.

Device Number: JBDL-4E2-013

REV: 1.0

3.2*3.9mm Elliptical Wide Angle LED Lamps

Model No.: **346A25BXXD1**

ECN: _____

Page: 2/4

■ Absolute Maximum Ratings at Ta = 25°C

Parameter	Symbol	Rating	Unit
Forward Current	I _F	30	mA
Operating Temperature	T _{opr}	-40 to +85	°C
Storage Temperature	T _{stg}	-40 to +100	°C
Soldering Temperature	T _{sol}	260 ± 5	°C
Electrostatic Discharge	ESD	2000	V
Power Dissipation	P _d	120	mW
Peak Forward Current	I _{F(Peak)}	100	mA
Reverse Voltage	V _R	7	V

Note: *1:IFP Conditions --Pulse Width ≤ 1msec and Duty ≤ 1/10.

*2:Soldering time ≤ 5 seconds.

Electro-Optical Characteristics (Ta=25°C)

Parameter	Symbol	Condition	Min.	Typ.	Max.	Unit
Forward Voltage	V _F	I _F = 20 mA	3.0	3.2	3.4	V
Reverse Current	I _R	V _R = 7 V	/	/	2	μA
Luminous Intensity	I _v	I _F = 20 mA	400	620	/	mcd
Viewing Angle	2θ 1/2	I _F = 20 mA	/	80/40	/	deg
Peak Wavelength	λ _p	I _F = 20 mA	462	465	468	nm
Dominant Wavelength	λ _d	I _F = 20 mA	465	468	470	nm
Spectrum Radiation Bandwidth	Δλ	I _F = 20 mA	/	26	/	nm

BIN#	N17	N18	N19	N20
I _v (mcd) @I _F =20mA	370-444	444-532	532-639	639-767
BIN#	N21	N22		
I _v (mcd) @I _F =20mA	767-920	920-1104		

Address: Bld.8,Fuwan Industrial Zone,Eastern,Zhongshan,Guangdong,China

TEL : (+86 760) 86185231 86185232 86185233 86185201

FAX : (+86 760) 86185230

E-mail:Sales@kinghood.cc

Http://www.kinghood.cc

Prepared by : George

Prepared date : 09-6-14

906028



中山市晶博光电科技有限公司

ZHONGSHAN KINGHOOD OPTOELECTRONICS CO.,LTD.

Device Number: JBDL-4E2-013

REV: 1.0

3.2*3.9mm Elliptical Wide Angle LED Lamps

Model No.: 346A25BXXD1

ECN: _____

Page: 3/4

■ Typical Electro-Optical Characteristic Curves:

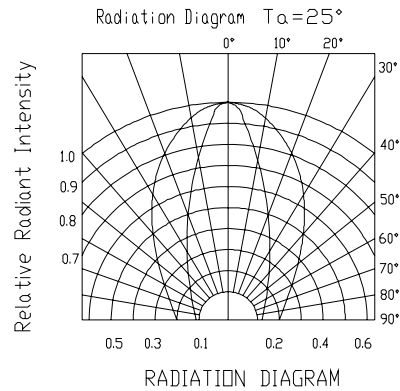
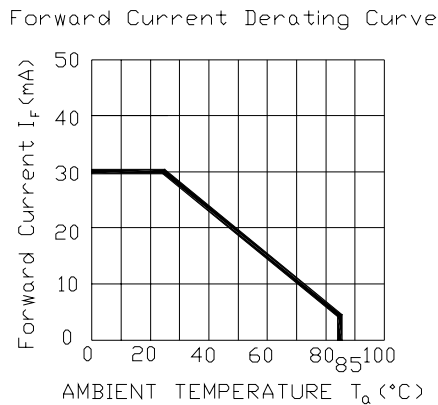
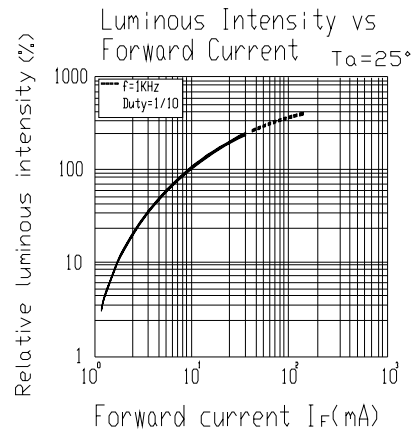
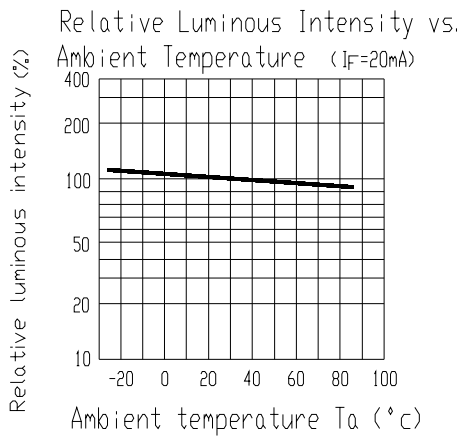
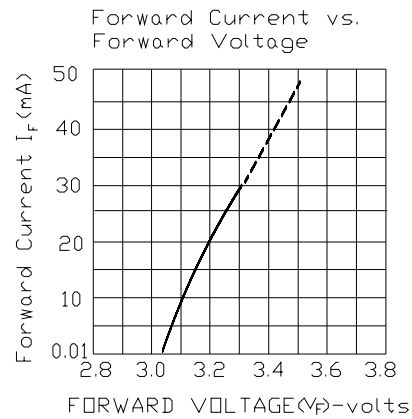
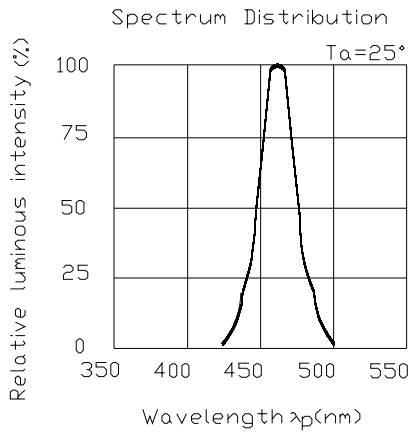

Address: Bld.8,Fuwan Industrial Zone,Eastern,Zhongshan,Guangdong,China

TEL : (+86 760) 86185231 86185232 86185233 86185201

Prepared date : 09-6-14

FAX : (+86 760) 86185230

Prepared by : George

E-mail:Sales@kinghood.cc

Http://www.kinghood.cc

906028



中山市晶博光电科技有限公司
ZHONGSHAN KINGHOOD OPTOELECTRONICS CO.,LTD.

Device Number: JBDL-4E2-013

REV: 1.0

3.2*3.9mm Elliptical Wide Angle LED Lamps

Model No.: 346A25BXXD1

ECN: _____

Page: 4/4

■ Reliability test items and conditions:

NO	Item	Test Conditions	Test Hours/Cycle	Sample size	Ac/Re
1	Solder Heat	TEMP : 260°C ± 5 °C	10 SEC	76 PCS	0/1
2	Temperature Cycle	H : +100°C 15min ∩ 5 min L : -40°C 15min	300 CYCLES	76 PCS	0/1
3	Thermal Shock	H : +100°C 5min ∩ 10 sec L : -10°C 5min	300 CYCLES	76 PCS	0/1
4	High Temperature Storage	TEMP : 100°C	1000 HRS	76 PCS	0/1
5	Low Temperature Storage	TEMP : -40°C	1000 HRS	76 PCS	0/1
6	DC Operating Life	TEMP : 25°C IF = 20mA	1000 HRS	76 PCS	0/1
7	High Temperature/ High Humidity	85°C / 85% RH	1000 HRS	76 PCS	0/1

*IV: BRIGHTNESS ATTENUATE DIFFERENCE(1000hrs) < 10%

*VF: FORWARD VOLTAGE DIFFERENCE < 3%

Address: Bld.8,Fuwan Industrial Zone,Eastern,Zhongshan,Guangdong,China

TEL : (+86 760) 86185231 86185232 86185233 86185201

FAX : (+86 760) 86185230

E-mail:Sales@kinghood.cc

Http://www.kinghood.cc

Prepared date : 09-6-14

Prepared by : George

906028