



中山市晶博光电科技有限公司

ZHONGSHAN LUCKY OPTOELECTRONICS CO.,LTD.

DATA SHEET

PART NO. : 5R4B92RGCA

DATE : 2009-10-6

DEPARTMENT : R&D

REVISION : 1.0

RECEIVED			
<input type="checkbox"/> MASS PRODUCTION			
<input checked="" type="checkbox"/> PRELIMINARY			
<input type="checkbox"/> CUSTOMER DESIGN			
DEVICE NUMBER :		JBDL-5R4-001	
PAGE :		5	
CUSTOMER	DESIGNER	CHECKER	APPROVER

REV.	DESCRIPTION	RELEASE DATE

Address : Bld.8,Fuwan Industrial Zone,Eastern,Zhongshan,Guangdong,China

TEL : (+86 760) 86185231 86185232 86185233 86185201

FAX : (+86 760) 86185230

E-mail:Sales@kinghood.cc

Http://www.kinghood.cc



中山市晶博光电科技有限公司

ZHONGSHAN LUCKY OPTOELECTRONICS CO.,LTD.

Device Number: JBDL-5R4-001

REV: 1.0

5.0mm Multi-Color Round Type LED Lamps

Model No.: 5R4B92RGCA

ECN: _____

Page: 1/5

■ Features :

- Two chips are matched for uniform light output, wide viewing angle
- Long life-solid state reliability
- I.C. compatible/Low power consumption

■ Descriptions :

- The LED lamp contain two integral chips and is available as both bicolor and bipolar types.

■ Applications :

- TV set
- Monitor
- Telephone
- Computer

■ Package Dimensions:

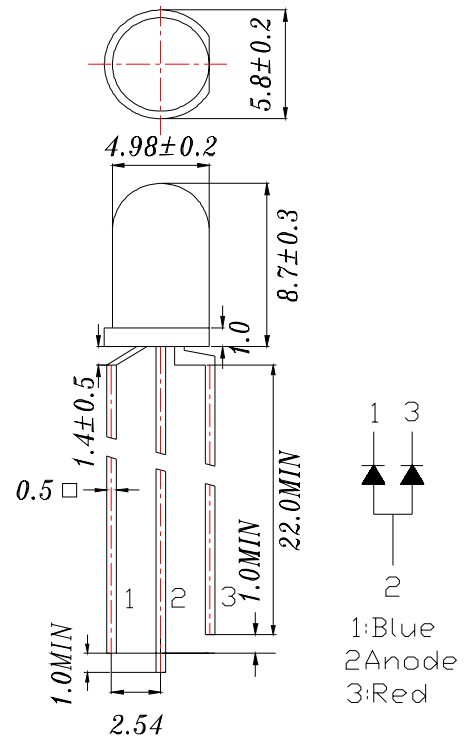

- Notes:**
1. All dimensions are in millimetres
 2. An epoxy meniscus may extend about 1.5 mm(0.059 ") down to the lead.
 3. Tolerances unless Dimension ± 0.25 mm.

PART NO.	Chip		Lens Color
	Material	Emitted Color	
5R4B92RGCA	GaP	Green	Water Clear
	GaAsP/GaP	Orange	

Address: Bld.8,Fuwan Industrial Zone,Eastern,Zhongshan,Guangdong,China

TEL : (+86 760) 86185231 86185232 86185233 86185201

FAX : (+86 760) 86185230

E-mail:Sales@kinghood.cc

Http://www.kinghood.cc

Prepared by: George

Prepared date: 09-10-6

910001



中山市晶博光电科技有限公司

ZHONGSHAN LUCKY OPTOELECTRONICS CO.,LTD.

Device Number: JBDL-5R4-001

REV: 1.0

5.0mm Multi-Color Round Type LED Lamps

Model No.: 5R4B92RGCA

ECN: _____ Page: 2/5

Absolute Maximum Ratings at Ta = 25°C

Parameter	Symbol	Rating	Unit
Forward Current	IF	G15	30
		R92	30
Power Dissipation	Pd	G15	120
		R92	100
Peak Forward Current	IF(Peak)	G15	100
		R92	160
Operating Temperature	Topr	-40 to +85	°C
Storage Temperature	Tstg	-40 to +100	°C
Soldering Temperature	Tsol	260 ± 5	°C
Electrostatic Discharge	ESD	150	V
Reverse Voltage	VR	5	V

Note: *1:IFP Conditions --Pulse Width ≤ 1msec and Duty ≤ 1/10.

*2:Soldering time ≤ 5 seconds.

Electro-Optical Characteristics (Ta=25°C)

Parameter	Symbol	Min.	Typ.	Max.	Unit	Condition
Luminous Intensity	Iv	G15	700	1700	/	mcd IF= 20 mA
		R92	200	500	/	
Peak Wavelength	λ p	G15	/	525	/	nm IF= 20 mA
		R92	/	625	/	
Dominant Wavelength	λ d	G15	/	520	/	nm IF= 20 mA
		R92	/	635	/	
Spectrum Radiation Bandwidth	Δ λ	G15	/	35	/	nm IF= 20 mA
		R92	/	45	/	
Forward Voltage	VF	G15	/	3.1	3.4	V IF= 20 mA
		R92	/	1.9	2.2	
Viewing Angle	2 θ 1/2	/	45	/	deg	IF= 20 mA
Reverse Current	IR	/	/	10	μ A	VR= 5 V

Address : Bld.8,Fuwan Industrial Zone,Eastern,Zhongshan,Guangdong,China

TEL : (+86 760) 86185231 86185232 86185233 86185201

FAX : (+86 760) 86185230

E-mail:Sales@kinghood.cc

Http://www.kinghood.cc

Prepared by : George

Prepared date : 09-10-6

910001



中山市晶博光电科技有限公司

ZHONGSHAN LUCKY OPTOELECTRONICS CO.,LTD.

Device Number: JBDL-5R4-001

REV: 1

5.0mm Multi-Color Round Type LED Lamps

Model No.: 5R4B92RGCA

ECN: _____

Page: 3/5

Typical Electro-Optical Characteristic Curves:

G

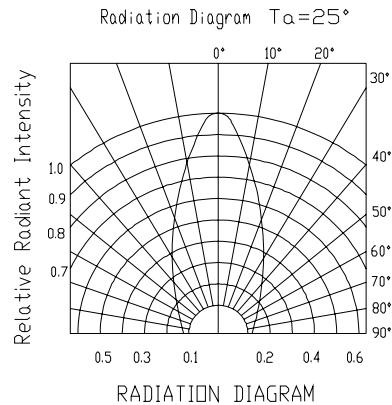
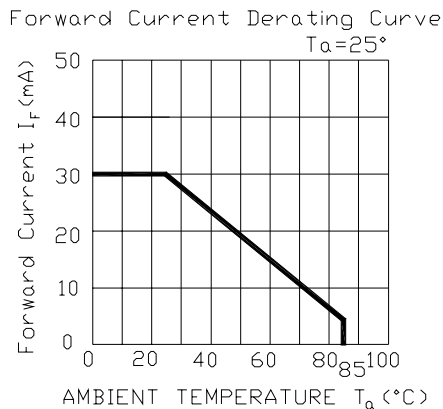
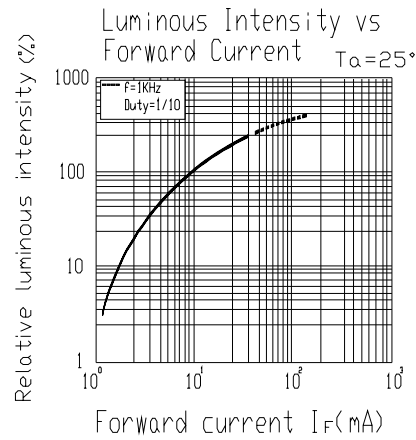
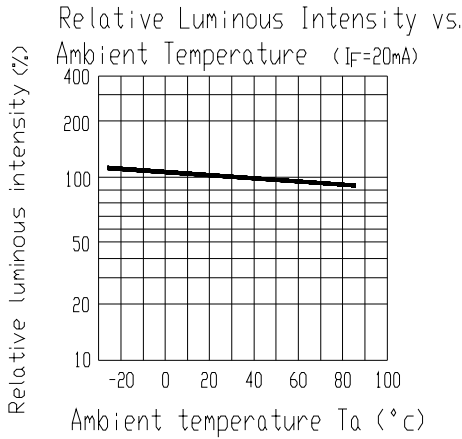
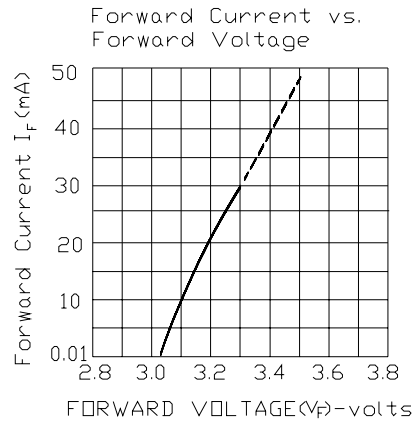
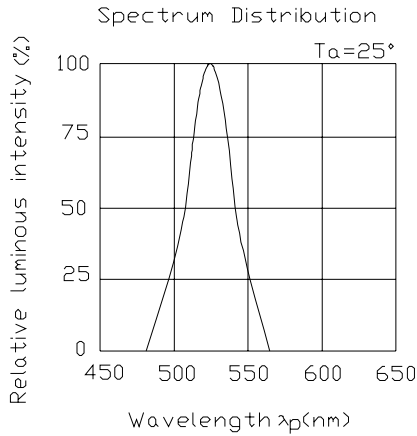

Address: Bld.8,Fuwan Industrial Zone,Eastern,Zhongshan,Guangdong,China

TEL : (+86 760) 86185231 86185232 86185233 86185201

FAX : (+86 760) 86185230

E-mail:Sales@kinghood.cc

Http://www.kinghood.cc

Prepared by: George

Prepared date: 09-10-6

910001



中山市晶博光电科技有限公司

ZHONGSHAN LUCKY OPTOELECTRONICS CO.,LTD.

Device Number: JBDL-5R4-001

REV: 1

5.0mm Multi-Color Round Type LED Lamps

Model No.: 5R4B92RGCA

ECN: _____

Page: 4/5

Typical Electro-Optical Characteristic Curves:

R

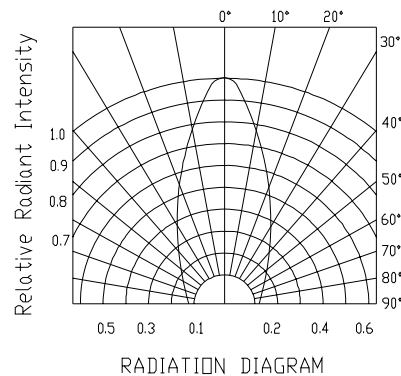
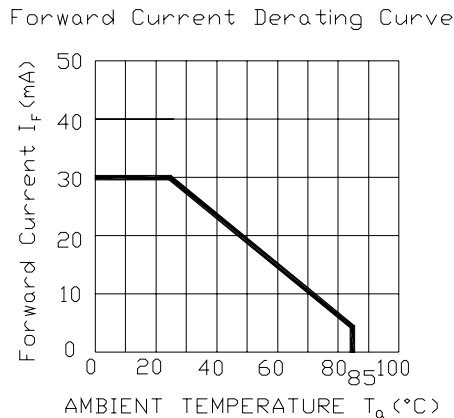
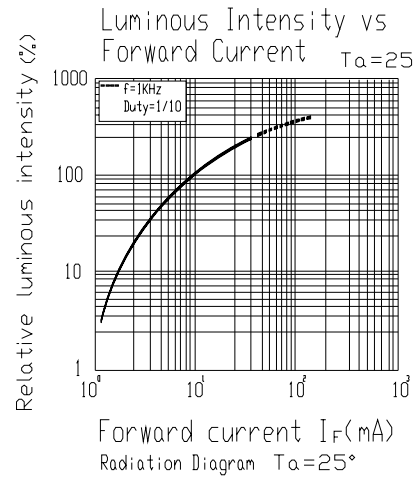
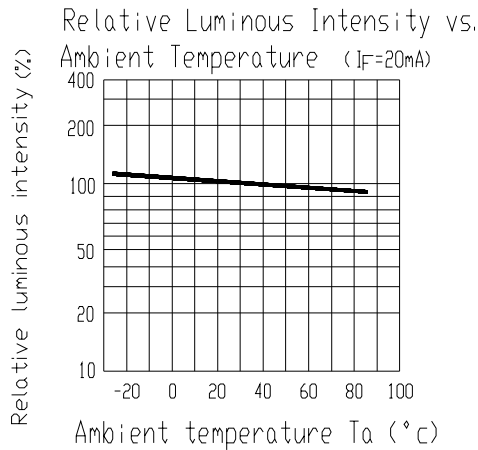
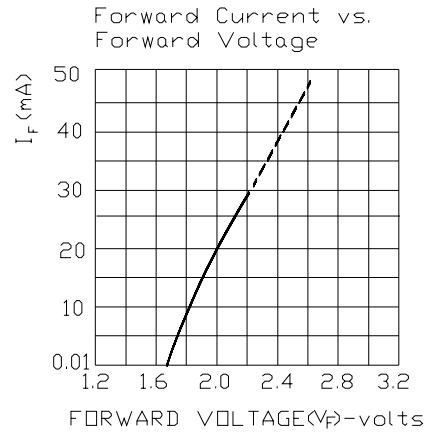
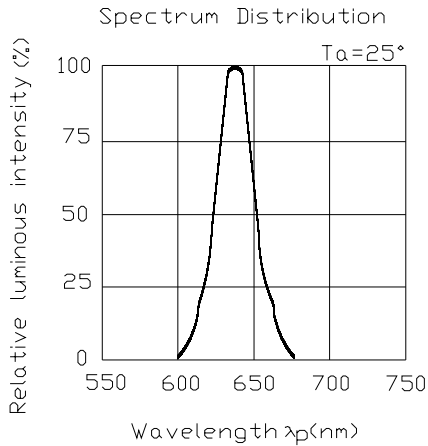

Address: Bld.8,Fuwan Industrial Zone,Eastern,Zhongshan,Guangdong,China

TEL : (+86 760) 86185231 86185232 86185233 86185201

FAX : (+86 760) 86185230

E-mail:Sales@kinghood.cc

Http://www.kinghood.cc

Prepared by : George

Prepared date : 09-10-6

910001



中山市晶博光电科技有限公司
ZHONGSHAN LUCKY OPTOELECTRONICS CO.,LTD.

Device Number: JBDL-5R4-001

REV: 1

5.0mm Multi-Color Round Type LED Lamps

Model No.: 5R4B92RGCA

ECN: _____

Page: 5/5

■ Reliability test items and conditions:

NO	Item	Test Conditions	Test Hours/Cycle	Sample size	Ac/Re
1	Solder Heat	TEMP : 260°C ± 5 °C	10 SEC	76 PCS	0/1
2	Temperature Cycle	H : +100°C 15min ∫ 5 min L : -40°C 15min	300 CYCLES	76 PCS	0/1
3	Thermal Shock	H : +100°C 5min ∫ 10 sec L : -10°C 5min	300 CYCLES	76 PCS	0/1
4	High Temperature Storage	TEMP : 100°C	1000 HRS	76 PCS	0/1
5	Low Temperature Storage	TEMP : -40°C	1000 HRS	76 PCS	0/1
6	DC Operating Life	TEMP : 25°C IF = 20mA	1000 HRS	76 PCS	0/1
7	High Temperature/ High Humidity	85°C / 85% RH	1000 HRS	76 PCS	0/1

Address: Bld.8,Fuwan Industrial Zone,Eastern,Zhongshan,Guangdong,China

TEL : (+86 760) 86185231 86185232 86185233 86185201

FAX : (+86 760) 86185230

E-mail:Sales@kinghood.cc

Http://www.kinghood.cc

Prepared date : 09-10-6

Prepared by : George

910001