



# 中山市晶博光电科技有限公司

## ZHONGSHAN KINGHOOD OPTOELECTRONICS CO.,LTD.

Device Number: JBDL-5RA-009

REV: 1.0

### 5.0mm Round Type LED Lamps

Model No.: 5RAC35YXXC

ECN: \_\_\_\_\_

Page: 1/4

#### ■ Features :

- High radiant intensity
- Choice of various viewing angles
- Reliable and robust

#### ■ Descriptions :

- The series is specially designed for applications requiring higher brightness.
- The led lamps are available with different colors, intensities, epoxy colors, etc.

#### ■ Applications :

- TV set
- Monitor
- Telephone
- Computer

#### ■ Package Dimensions:

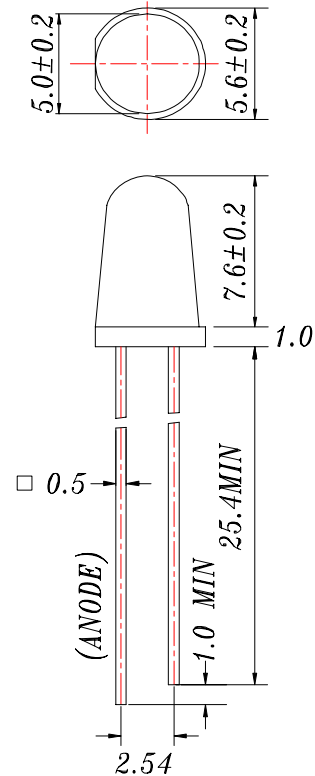

- Notes:**
1. All dimensions are in millimetres
  2. An epoxy meniscus may extend about 1.5mm(0.059") down to the lead.
  3. Tolerances unless Dimension  $\pm 0.25$ mm.

| PART NO.   | Chip     |               | Lens Color  |
|------------|----------|---------------|-------------|
|            | Material | Emitted Color |             |
| 5RAC35YXXC | AlGaInP  | Super Yellow  | Water Clear |

Address: Bld.8,Fuwan Industrial Zone,Eastern,Zhongshan,Guangdong,China

TEL : (+86 760) 86185231 86185232 86185233 86185201

FAX : (+86 760) 86185230

E-mail:Sales@kinghood.cc

Http://www.kinghood.cc

Prepared by: George

Prepared date: 09-7-15

907034



# 中山市晶博光电科技有限公司

ZHONGSHAN KINGHOOD OPTOELECTRONICS CO.,LTD.

Device Number: JBDL-5RA-009

REV: 1.0

5.0mm Round Type LED Lamps

Model No.: **5RAC35YXXC**

ECN: \_\_\_\_\_

Page: 2/4

## ■ Absolute Maximum Ratings at Ta = 25°C

| Parameter             | Symbol   | Rating      | Unit |
|-----------------------|----------|-------------|------|
| Forward Current       | IF       | 30          | mA   |
| Operating Temperature | Topr     | -40 to +85  | °C   |
| Storage Temperature   | Tstg     | -40 to +100 | °C   |
| Soldering Temperature | Tsol     | 260 ± 5     | °C   |
| Power Dissipation     | Pd       | 100         | mW   |
| Peak Forward Current  | IF(Peak) | 180         | mA   |
| Reverse Voltage       | VR       | 7           | V    |

Note: \*1:IFP Conditions --Pulse Width ≤ 1msec and Duty ≤ 1/10.

\*2:Soldering time ≤ 5 seconds.

## Electro-Optical Characteristics (Ta=25°C)

| Parameter                    | Symbol | Condition | Min. | Typ. | Max.  | Unit |
|------------------------------|--------|-----------|------|------|-------|------|
| Forward Voltage              | VF     | IF= 20 mA | 1.9  | 2.0  | 2.2   | V    |
| Reverse Current              | IR     | VR= 7 V   | /    | /    | 2     | μA   |
| Luminous Intensity           | Iv     | IF= 20 mA | 3000 | /    | 20000 | mcd  |
| Viewing Angle                | 2θ 1/2 | IF= 20 mA | /    | 7    | /     | deg  |
| Peak Wavelength              | λ p    | IF= 20 mA | 587  | 591  | 593   | nm   |
| Dominant Wavelength          | λ d    | IF= 20 mA | 585  | 589  | 595   | nm   |
| Spectrum Radiation Bandwidth | Δλ     | IF= 20 mA | /    | 15   | /     | nm   |

| BIN#                | M15        | M16         | M17         | M18       |
|---------------------|------------|-------------|-------------|-----------|
| Iv(mcd)<br>@IF=20mA | 2222-3111  | 3111-4356   | 4356-6098   | 6098-8538 |
| BIN#                | M19        | M20         | M21         |           |
| Iv(mcd)<br>@IF=20mA | 8538-11953 | 11953-16734 | 16734-23427 |           |

Address: Bld.8,Fuwan Industrial Zone,Eastern,Zhongshan,Guangdong,China

TEL : (+86 760) 86185231 86185232 86185233 86185201

FAX : (+86 760) 86185230

E-mail:Sales@kinghood.cc

Http://www.kinghood.cc

Prepared by : George

Prepared date : 09-7-15

907034



# 中山市晶博光电科技有限公司

## ZHONGSHAN KINGHOOD OPTOELECTRONICS CO.,LTD.

Device Number: JBDL-5RA-009

REV: 1.0

5.0mm Round Type LED Lamps

Model No.: 5RAC35YXXC

ECN: \_\_\_\_\_

Page: 3/4

### Typical Electro-Optical Characteristic Curves:

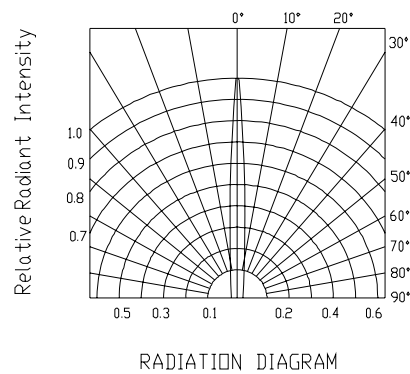
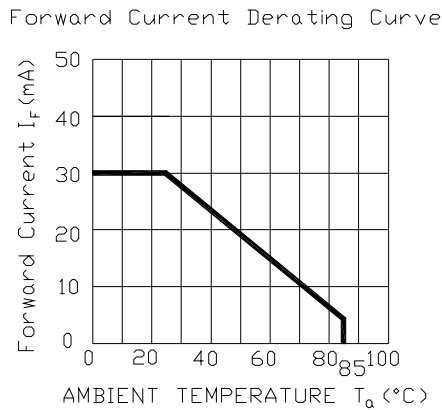
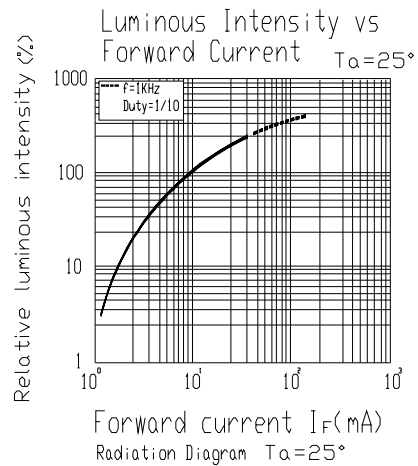
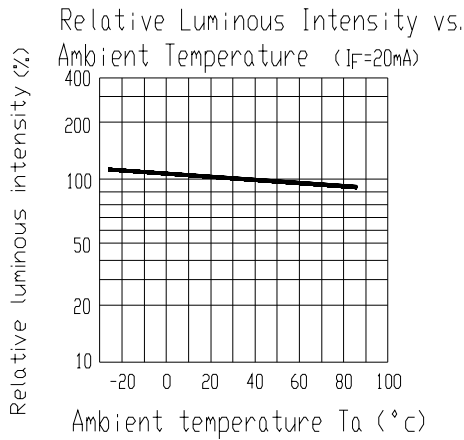
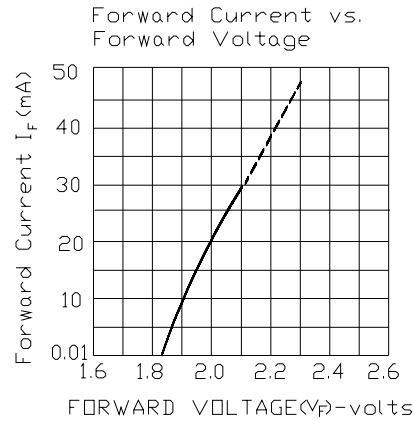
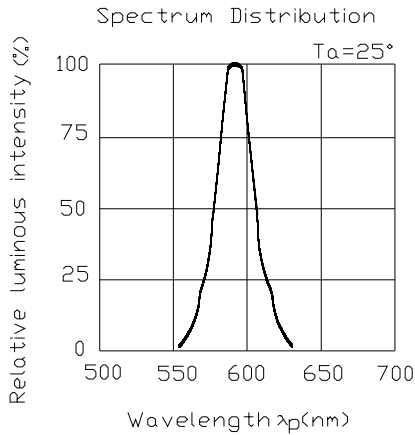

Address: Bld.8,Fuwan Industrial Zone,Eastern,Zhongshan,Guangdong,China

TEL : (+86 760) 86185231 86185232 86185233 86185201

Prepared date : 09-7-15

FAX : (+86 760) 86185230

Prepared by : George

E-mail:Sales@kinghood.cc

Http://www.kinghood.cc

907034



中山市晶博光电科技有限公司  
ZHONGSHAN KINGHOOD OPTOELECTRONICS CO.,LTD.

Device Number: JBDL-5RA-009

REV: 1.0

5.0mm Round Type LED Lamps

Model No.: 5RAC35YXXC

ECN: \_\_\_\_\_

Page: 4/4

■ Reliability test items and conditions:

| NO | Item                            | Test Conditions                                | Test Hours/Cycle | Sample size | Ac/Re |
|----|---------------------------------|--|------------------|-------------|-------|
| 1  | Solder Heat                     | TEMP : 260°C ± 5 °C                            | 10 SEC           | 76 PCS      | 0/1   |
| 2  | Temperature Cycle               | H : +100°C 15min<br>∩ 5 min<br>L : -40°C 15min | 300 CYCLES       | 76 PCS      | 0/1   |
| 3  | Thermal Shock                   | H : +100°C 5min<br>∩ 10 sec<br>L : -10°C 5min  | 300 CYCLES       | 76 PCS      | 0/1   |
| 4  | High Temperature Storage        | TEMP : 100°C                                   | 1000 HRS         | 76 PCS      | 0/1   |
| 5  | Low Temperature Storage         | TEMP : -40°C                                   | 1000 HRS         | 76 PCS      | 0/1   |
| 6  | DC Operating Life               | TEMP : 25°C<br>IF = 20mA                       | 1000 HRS         | 76 PCS      | 0/1   |
| 7  | High Temperature/ High Humidity | 85°C / 85% RH                                  | 1000 HRS         | 76 PCS      | 0/1   |

\*Iv: BRIGHTNESS ATTENUATE DIFFERENCE(1000hrs) < 10%

\*VF: FORWARD VOLTAGE DIFFERENCE < 3%

Address: Bld.8,Fuwan Industrial Zone,Eastern,Zhongshan,Guangdong,China

TEL : (+86 760) 86185231 86185232 86185233 86185201

FAX : (+86 760) 86185230

E-mail:Sales@kinghood.cc

Http://www.kinghood.cc

Prepared date : 09-7-15

Prepared by : George

907034